

ICS series

ICS-300

Narada's ICS series battery designed to provide highcycling and fast charge performance, idea for telecom service where power supply is unstable. With innovative structure design, high quality manufacturing and high quality material, ICS batteries are also capable of PSoC, hybrid, renewable energy storage application and other cycling/standby applications.



Specifications

Battery Model	ICS-300	
Nominal voltage	2V	
Capacity	300Ah (10HR ,30A, 1.80V, 25°C)	
Approx.Weight	22kg	
Internal Resistance	Approx 0.42mΩ	
Max Charge Current Allowed	75A	
Charge Voltage (25°C)	Cycle use	Float use
	2.35V/cell	2.27V/cell
Temperature Ranges	Operation(maximum): -40°C to 55°C (-40°F to 131°F)	
	Operation(recommended): 15°C to 25°C (59°F to 77°F)	
	Storage: -20°C to 40°C (-4°F to 104°F)	
Terminal	M8 Female	
Terminal Hardware	15 ± 1.0 N.m	
Container Material	ABS (V0 optional)	

Dimensions (mm)

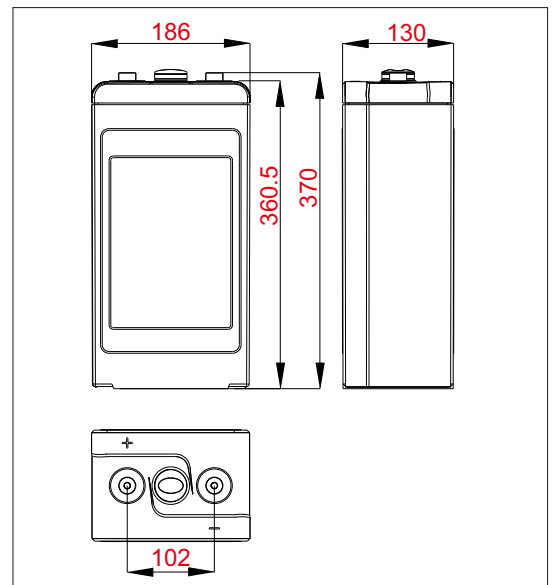

Constant Current Discharge Data Units: Amperes (25°C, 77°F)

End voltage per cell	15min	20min	30min	40min	50min	1h	2h	3h	5h	8h	10h
1.65V	360	320	265	230	210	172	105	80.0	55.0	38.0	33.0
1.70V	330	305	245	220	200	170	103	78.0	52.0	36.0	32.0
1.75V	310	280	230	210	185	168	102	77.0	50.0	35.0	31.0
1.80V	270	255	220	195	165	166	100	76.0	48.0	34.0	30.5

Constant Power Discharge Data Units: Watts per cell (25°C, 77°F)

End voltage per cell	15min	20min	30min	40min	50min	1h	2h	3h	5h	8h	10h
1.65V	690	600	520	440	390	330	215	170	120	84.0	80.0
1.70V	640	580	490	425	370	320	210	160	115	80.5	75.0
1.75V	600	550	450	400	360	310	205	155	110	77.0	66.0
1.80V	530	480	420	360	315	305	200	145	105	73.5	60.0

ICS series

ICS-300

Discharge Voltage vs Time Curve (25°C)

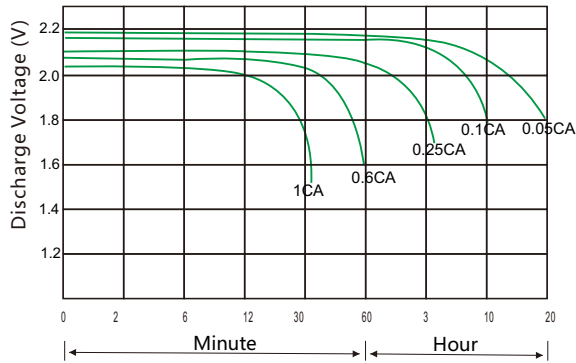

Charge Curve (25°C)

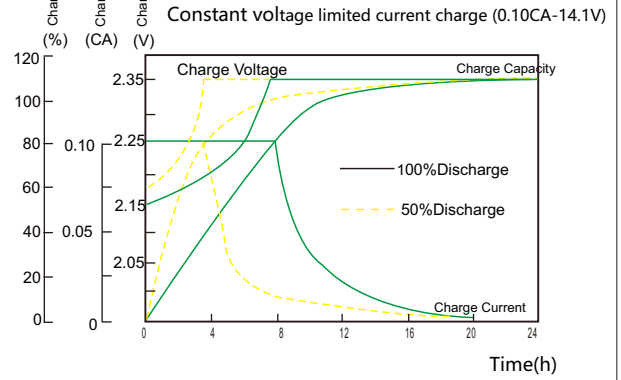

Capacity vs temperature curve

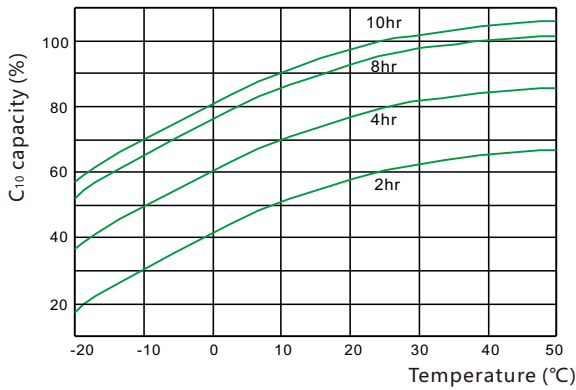

Residual Capacity vs Storage Time

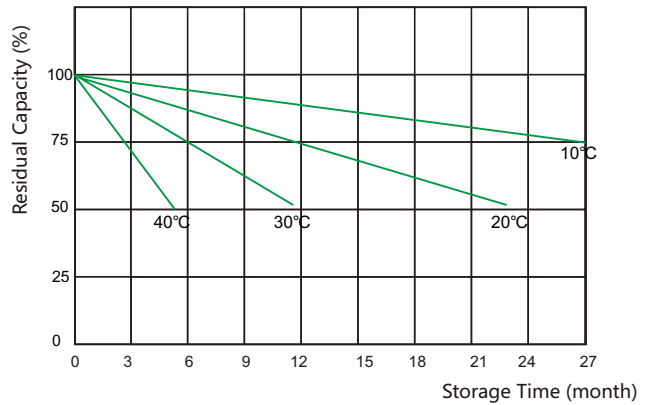

Capacity vs OCV curve

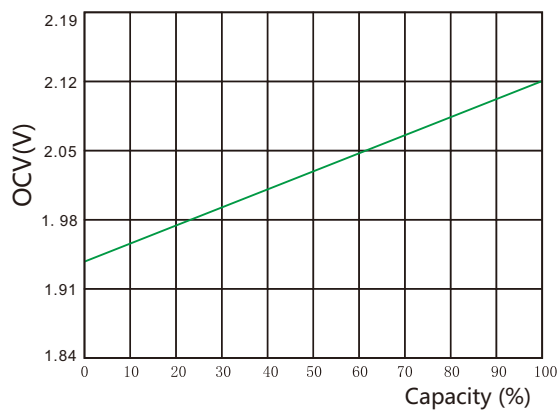

Design life vs temperature

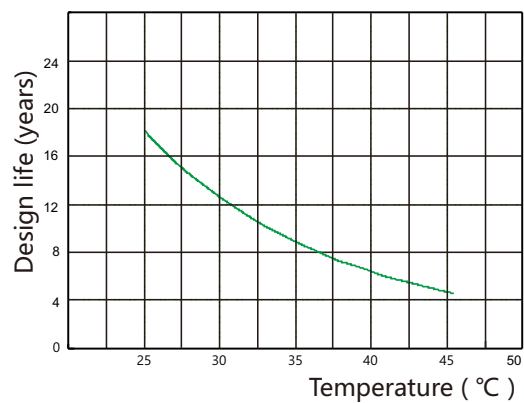

NARADA POWER SOURCE CO.,LTD.
 Building A, No.822 Wen'er West Road, Hangzhou, China
 Tel:+86-571-56975980 Fax:+86-571-56975955
 E-mail: intl@narada.biz
 Website:www.naradapower.com

NARADA ASIA PACIFIC PTE.LTD.
 Block 9 Khaki Bukit Road 1 #02-10 Eunos Technolink,
 Singapore 415938 Email: sales@narada-ap.com
 Tel: +65-6848 1191 Fax: +65-6749 3498
 Website: www.narada-ap.com

NARADA EUROPE (UK) LIMITED
 Spectrum House, Dunstable Road, Redbourn,
 St. Albans, Herts AL3 7PR
 Tel: +44 (0)845 371 7095 Fax:+44 (0)845 612 2031
 E-mail: sales@naradaeurope.com

