

**ICS series**

**ICS-200**

Narada's ICS series battery designed to provide highcycling and fast charge performance, idea for telecom service where power supply is unstable. With innovative structure design, high quality manufacturing and high quality material, ICS batteries are also capable of PSoC, hybrid, renewable energy storage application and other cycling/standby applications.



**Specifications**

<b>Battery Model</b>	<b>ICS-200</b>	
Nominal voltage	2V	
Capacity	200Ah (10HR ,20A, 1.80V, 25°C)	
Approx.Weight	17kg	
Internal Resistance	Approx 0.58mΩ	
Max Charge Current Allowed	50A	
Charge Voltage (25°C)	Cycle use	Float use
	2.35V/cell	2.27V/cell
Temperature Ranges	Operation(maximum): -40°C to 55°C (-40°F to 131°F)	
	Operation(recommended): 15°C to 25°C ( 59°F to 77°F)	
	Storage: -20°C to 40°C (-4°F to 104°F)	
Terminal	M8 Female	
Terminal Hardware	15 ± 1.0 N.m	
Container Material	ABS (V0 optional)	

**Dimensions (mm)**

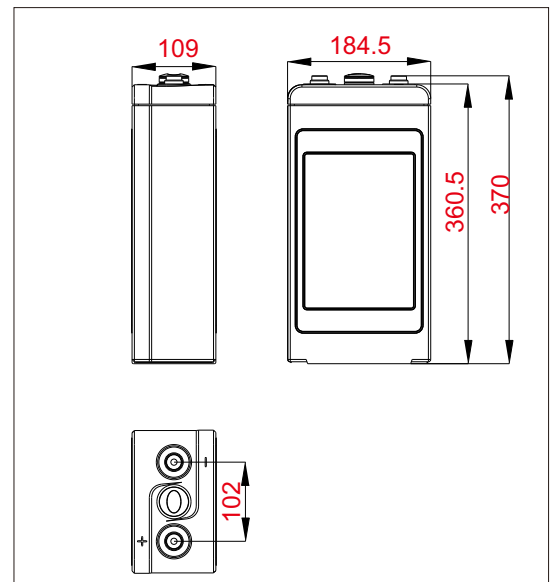

**Constant Current Discharge Data Units: Amperes (25°C, 77°F)**

End voltage per cell	15min	20min	30min	40min	50min	1h	2h	3h	5h	8h	10h
1.65V	230	215	180	155	140	115	70.0	54.0	37.0	26.0	22.0
1.70V	215	205	165	145	135	113	68.0	53.0	35.0	25.0	21.5
1.75V	205	180	150	135	125	112	67.0	52.0	33.0	24.0	21.0
1.80V	180	160	140	120	115	111	65.0	51.0	31.0	22.0	20.5

**Constant Power Discharge Data Units: Watts per cell (25°C, 77°F)**

End voltage per cell	15min	20min	30min	40min	50min	1h	2h	3h	5h	8h	10h
1.65V	450	400	345	280	260	215	145	115	80.0	56.0	52.0
1.70V	420	385	325	270	245	210	140	110	75.0	51.0	48.0
1.75V	400	360	310	260	235	205	135	105	70.0	48.0	42.0
1.80V	350	325	270	245	210	200	130	100	65.0	44.0	35.0

**ICS series**

**ICS-200**

**Discharge Voltage vs Time Curve ( 25°C )**

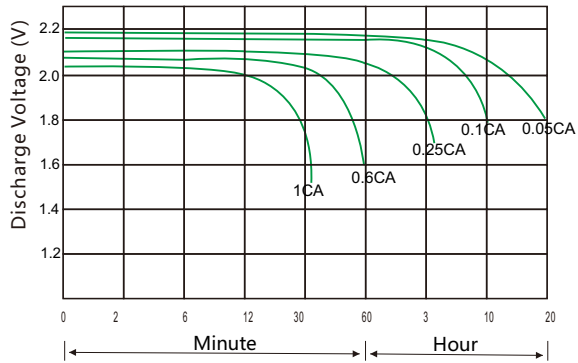

**Charge Curve (25°C)**

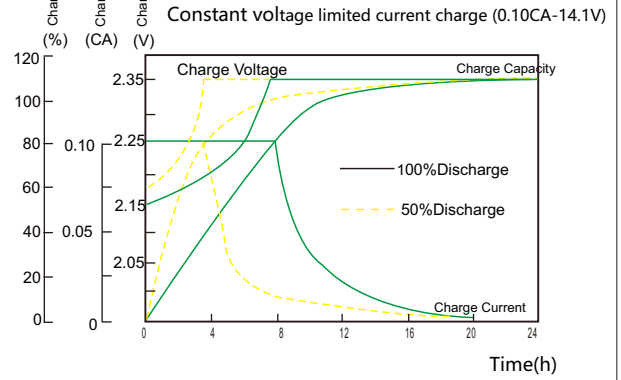

**Capacity vs temperature curve**

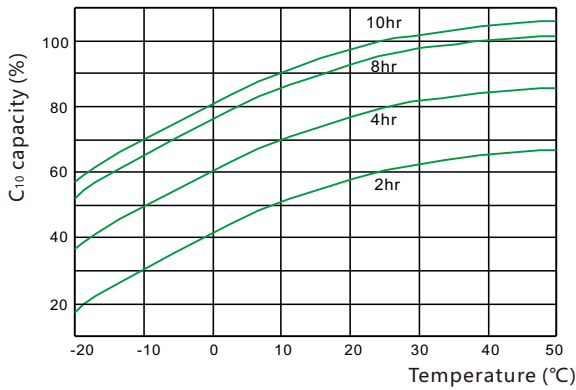

**Residual Capacity vs Storage Time**

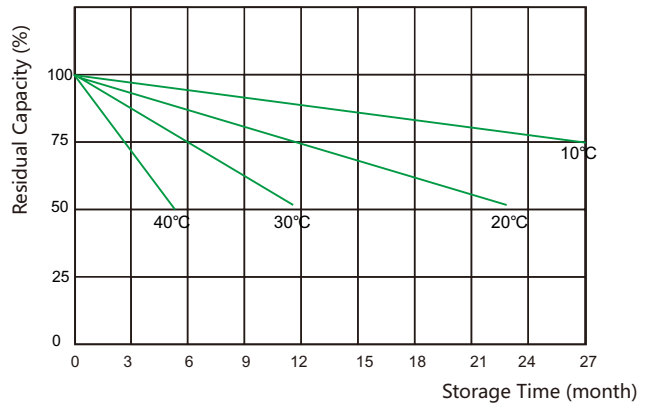

**Capacity vs OCV curve**

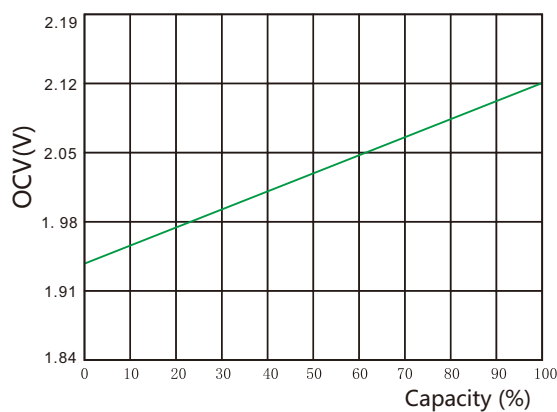

**Design life vs temperature**

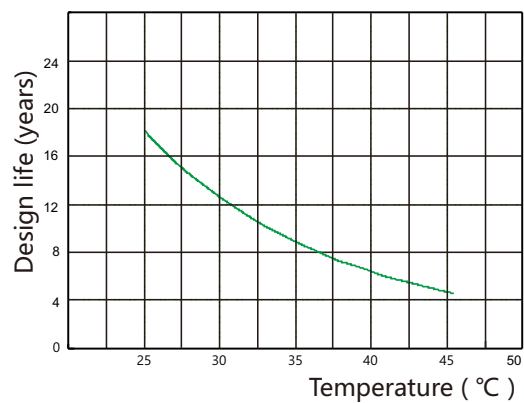

**NARADA POWER SOURCE CO.,LTD.**  
 Building A, No.822 Wen'er West Road, Hangzhou, China  
 Tel:+86-571-56975980 Fax:+86-571-56975955  
 E-mail: intl@narada.biz  
 Website:www.naradapower.com

**NARADA ASIA PACIFIC PTE.LTD.**  
 Block 9 Khaki Bukit Road 1 #02-10 Eunos Technolink,  
 Singapore 415938 Email: sales@narada-ap.com  
 Tel: +65-6848 1191 Fax: +65-6749 3498  
 Website: [www.narada-ap.com](http://www.narada-ap.com)

**NARADA EUROPE (UK) LIMITED**  
 Spectrum House, Dunstable Road, Redbourn,  
 St. Albans, Herts AL3 7PR  
 Tel: +44 (0)845 371 7095 Fax:+44 (0)845 612 2031  
 E-mail: sales@naradaeurope.com

